

Zoom Lens

This zoom lens is designed for use with Panasonic's applicable projectors. The lens makes it possible to vary the projection distance by changing the focal distance.

NOTE: The lens cannot be used by itself. It must be mounted onto the specified Panasonic DLP™ projector.

Specifications

F value:	1.8–2.2
Focal distance (f):	52.8–79.5 mm
Throw ratio	WUXGA 3.6-5.4:1 for PT-RZ970/RZ770/RZ660/DZ870/DZ780 (16:10 aspect ratio) WXGA 3.8-5.7:1 for PT-RW930/RW730/RW620/DW830/DW750 (16:10 aspect ratio) XGA 3.7-5.6:1 for PT-RX110/DX100/DX820 (4:3 aspect ratio)
Dimensions (W × H × D):	95 × 95 × 169 mm (3-3/4 × 3-3/4 × 6-21/32 inches)
Weight:	1.1 kg (2.4 lbs)
Applicable projector:	Group A PT-DZ870K/DZ870LK/DZ870W/DZ870LW/DW830K/DW830LK/DW830W/DW830LW/ DX100K/DX100LK/DX100W/DX100LW Group B PT-DZ770K/DZ770LK/DZ770S/DZ770LS/DW740S/DW740LS/DW740K/DW740LK/ DW730S/DW730LS/DW730K/DW730LK/DX810S/DX810LS/DX810K/DX810LK/DX800S/ DX800LS/DX800K/DX800LK/DZ680K/DZ680LK/DZ680S/DZ680LS/DW640K/DW640LK/ DW640S/DW640LS/DX610K/DX610LK/DX610S/DX610LS/DZ6710/DZ6710L/DZ6700/ DZ6700L/DW6300S/DW6300LS/DW6300K/DW6300LK/D6000S/D6000LS/D6000K/ D6000LK/D5000S/D5000LS Group C PT-RZ970B/RZ970W/RZ970LB/RZ970LW/RW930B/RW930W/RW930LB/RW930LW/ RX110B/RX110W/RX110LB/RX110LW/RZ770B/RZ770W/RZ770LB/RZ770LW/ RW730B/RW730W/RW730LB/RW730LW/RZ660B/RZ660W/RZ660LB/RZ660LW/ RW620B/RW620W/RW620LB/RW620LW/RZ670B/RZ670W/RZ670LB/RZ670LW/ RW630B/RW630W/RW630LB/RW630LW Group D PT-DZ780/DZ780L/DW750/DW750L/DX820/DX820L

Dimensions

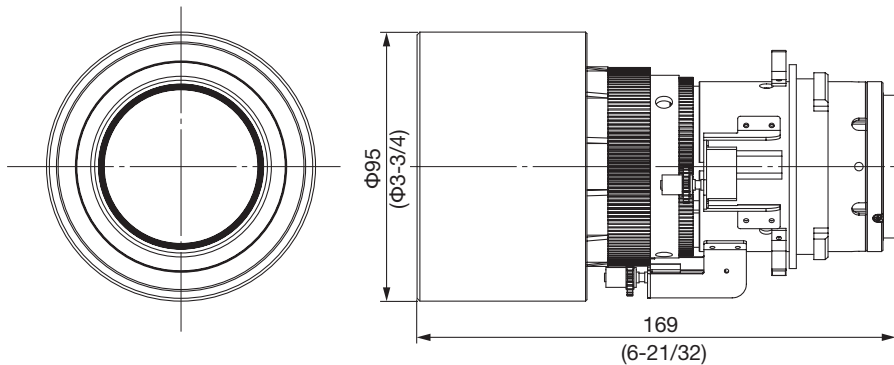
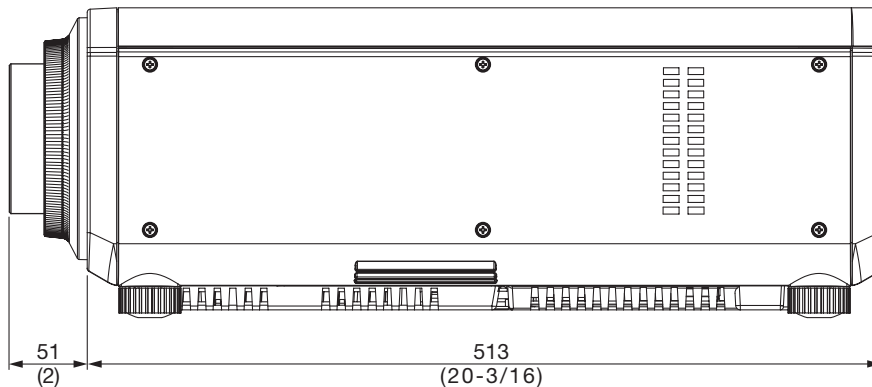

Illustration shows the lens attached to an applicable projector.

[Group A]



unit : mm (inch)

NOTE: This illustration is not drawn to scale.

[Group B]

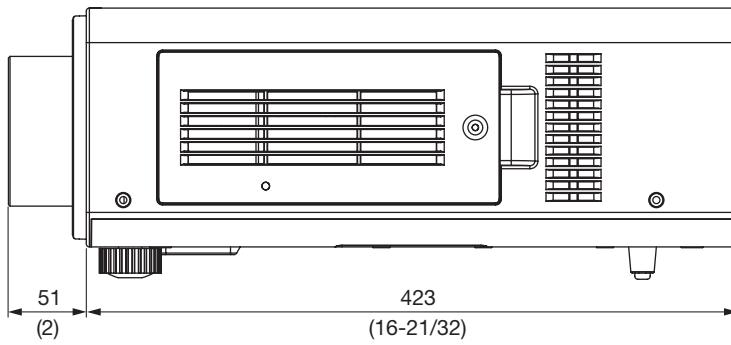

[Group C]

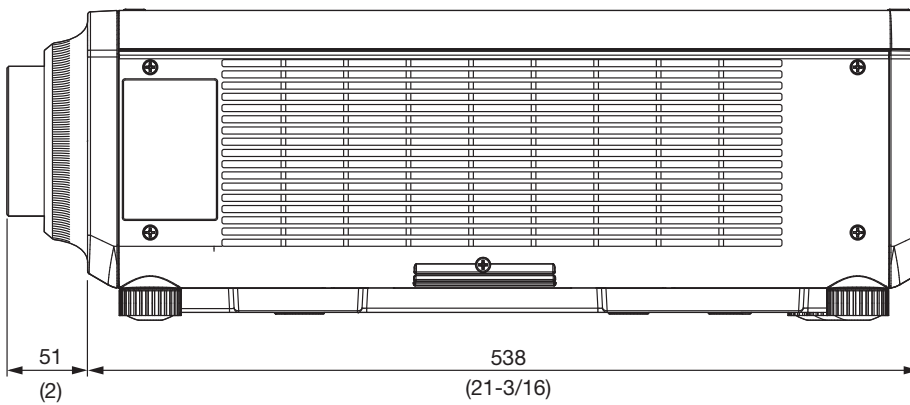

[Group D]

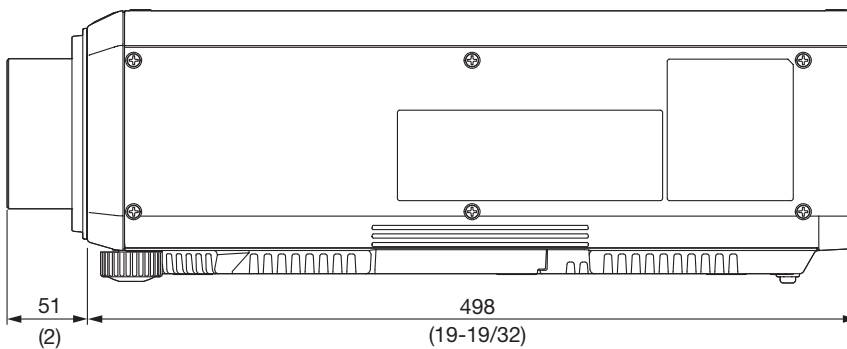

unit : mm (inch)
NOTE: This illustration is not drawn to scale.

For information on the projection distance, refer to the specifications for the projector to which the lens will be mounted.
DLP is a trademark of Texas Instruments. Weights and dimensions shown are approximate. Specifications subject to change without notice.